

ALU-SMART A clever sunshade



SWISS  DESIGN

Material and technology

- Frame:** 6 or 8 rods made of aluminium, anodized natural, with a profiled pole and stepless height adjustment. Upper pole 38.4 × 1.2 mm – lower pole 35 × 1.5 mm, tilting thanks to the tilt joint.
- Frame colour:** anodized natural
- Frame shape:** round, rectangular or square
- Shade cover:** self-tautening thanks to the flexible rod ends
material class 5 (100 % polyacrylic approx. 300 g/m²)
material class 4 (100 % polyester approx. 250 g/m²)
material class 2 (100 % polyester approx. 220 g/m²)
- Flounce:** not available
- Protective cover** optional



Area of use





Type of fastening



Assortment

Nominal size Lateral distance Area covered Height closed Clear headroom Total height Clearance height, sunshade part inclined Total height, sunshade inclined Foundation Minimum weight for base max. wind speed open perm.

Order no.
Frame
anodized natural

	cm A	cm AS	m ² B	cm E	cm F	cm G	cm K	cm L	cm C	kg	km/h (wind force)	
	⁸ ∅ 200	175	2.6	70...130	150...210	180...240	95...155	200...260	40×40	30	75 (9)	206 00 200 171
	⁹ ∅ 220	205	3.4	65...125	150...210	180...240	90...150	205...265	40×40	30	65 (8)	206 00 220 171
	⁹ ∅ 250	230	4.4	50...110	150...210	185...245	80...140	217...275	50×50	40	50 (7)	206 00 250 171
	⁹ ∅ 300	275	6.4	50...90	170...210	210...250	85...125	245...285	60×60	40	35 (5)	206 00 300 171
	⁸ 210×150	-	3.2	50...110	150...210	185...245	110...170	190...250	40×40	30	55 (7)	206 00 212 171
	⁸ 250×200	-	5.0	40...80	170...210	210...250	110...150	220...260	50×50	40	40 (6)	206 00 252 171
	⁹ 200×200	-	4.0	35...95	150...210	185...245	95...155	200...260	40×40	40	50 (7)	206 00 201 171
	⁹ 240×240	-	5.8	30...70	170...210	210...250	100...140	230...270	50×50	40	40 (6)	206 00 241 171

⁸6 parts

⁹8 parts

The listed measures represent extrapolated average values that may be slightly different on the product ($\pm 2\% \pm 5\text{ cm}$).

Height dimensions are based on ground socket BT. These vary slightly depending on the type of base. Except for steel base minus 5 cm.

The max. wind speed limits as per our separate sheet apply only if the sunshade canopy is in a horizontal position and if there is a fix ground anchorage.

In the presence of several sunshades, the minimum distance between one sunshade and another and between sunshades and walls shall be 20 cm.

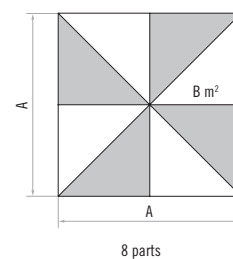
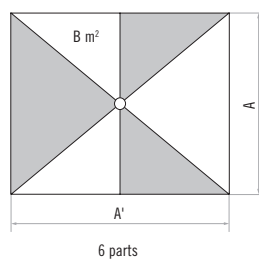
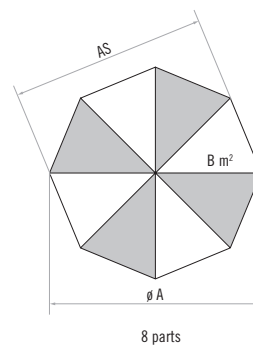
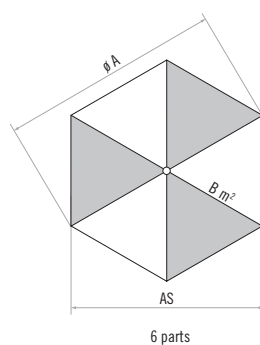
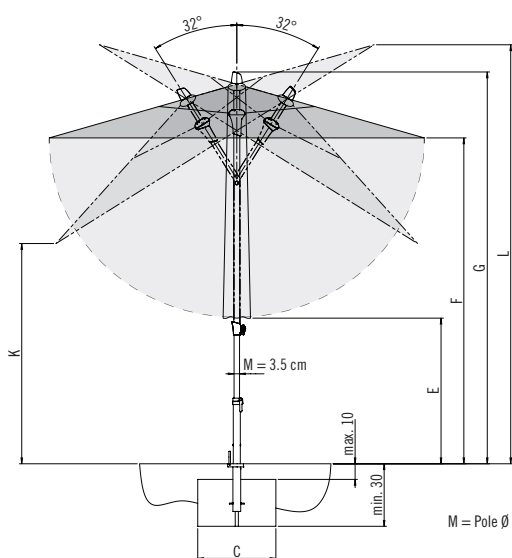

Loose cover max. 10 cm, concrete thickness min. 30 cm
(pay attention to frost depth), water outflow

Accessories

	Order no.
Fixing option Z (support tube Z absolutely necessary)	
1. Concrete base Z, 30 kg, $\varnothing 47 \times 8.5$ cm	350 01 109 532
1. Concrete base Z, 40 kg, $\varnothing 60 \times 8.5$ cm	350 01 109 529
2. ³ Granite base Z, 40 kg, $45 \times 45 \times 8$ cm, natural stone, with castors and retractable handle	350 01 109 465
3. ³ Granite base Z, 55 kg, $55 \times 55 \times 9$ cm, natural stone, with castors and retractable handle	350 01 109 445
4. Steel base Z, 40 kg, $58.5 \times 58.5 \times 2$ cm, galvanised steel	350 01 100 210
5. Wall bracket Z, 180 mm, galvanised steel	350 01 205 000
6. Lawn spike Z, $85 \times 150 \times 350$, galvanised steel	350 01 205 400
7. Support tube Z, $\varnothing 35/38 - 39$ mm, galvanised steel	350 01 201 010
7. Support tube Z, $\varnothing 35/38 - 39$ mm, high-grade steel 1.4301/304	350 01 201 100
³ Base with castors Z (support tube Z absolutely necessary)	
8. Base with castors Z, 55 kg, $65 \times 65 \times 11$ cm, cast concrete decor	350 01 102 900
³ Base with castors (Weight set absolutely necessary)	
9. Base frame with castors 45 kg, $50 \times 50 \times 12$ cm, anthracite, with support tube $\varnothing 35/38 - 39$ mm, polished aluminium (Base frame ca. 13 kg)	350 01 102 300
Weight Set, 4 pieces 35001105300, concrete, for base with castors 45 kg (Weight Set ca. 32 kg)	350 01 103 300
Protective cover for base with castors 45 kg	350 01 602 300
Fixing option BT (Connection tube BT absolutely necessary)	
10. Ground socket BT, galvanised steel	350 01 206 100
11. Connection tube BT $\varnothing 35/38 - 39$ mm, galvanised steel	350 01 206 210
Different fixing options	
12. Wall consoles U for the table top, $\varnothing 31 - 40$ mm, high-grade steel 1.4301/304, for horizontal flat railing, square profile up to 120 mm	350 01 252 005
Protective cover made of coated, tear-resistant polyester fabric	
13. Protective cover with zip and rod	350 01 609 980
Miscellaneous items	
14. Rechargeable battery light Osyryon 6 for pole $\varnothing 30 - 50$ mm, battery charger with european plug (type C) included 1 accumulator included	350 01 557 950
15. Rechargeable battery light Osyryon 4 for pole $\varnothing 30 - 50$ mm, battery charger with european plug (type C) included 1 accumulator included	350 01 557 910
Spare accu, 3.6 V, 2500 mAh (for Osyryon 4 & 6)	350 01 557 920

³only suitable for smooth, joint free surface coverings



